



LATINAMERICA

INFORMACIÓN TÉCNICA

PM 9



Grúas Hidráulicas Articuladas

 LA EXPERIENCIA NOS RESPALDA

Calidad italiana desde hace más de 50 años.



Seguridad



Versatilidad



Innovación



PM 9021

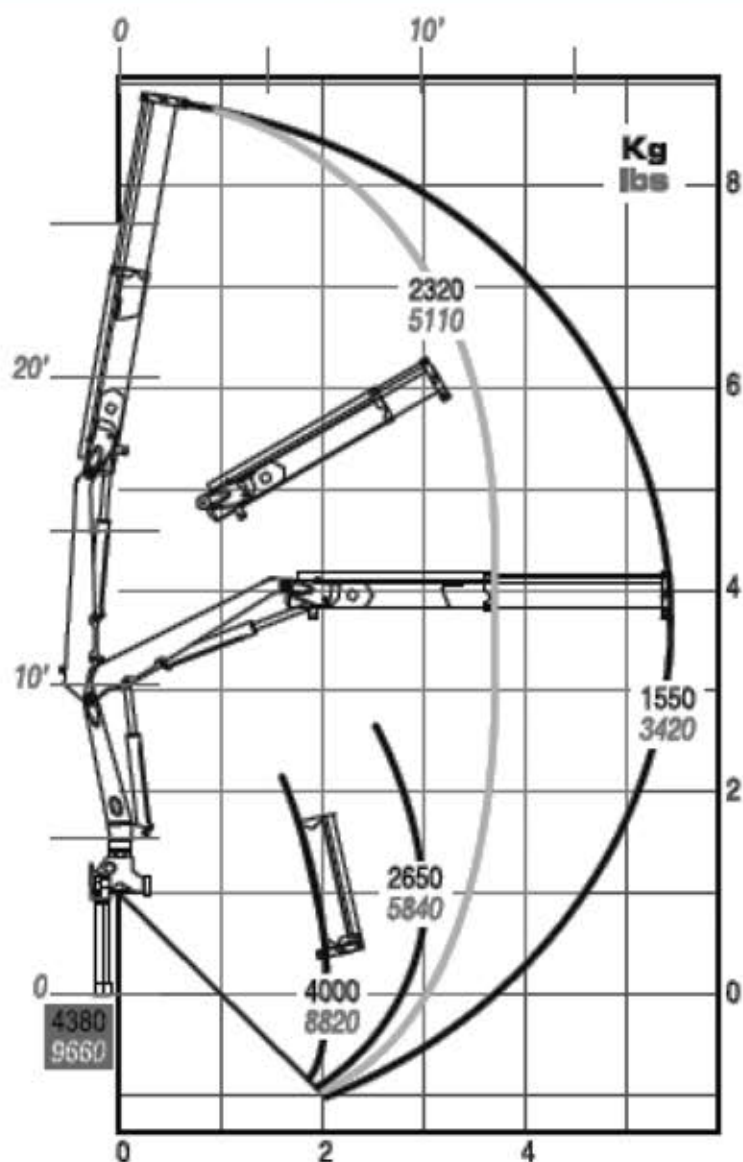

OIL & STEEL





PM 9022

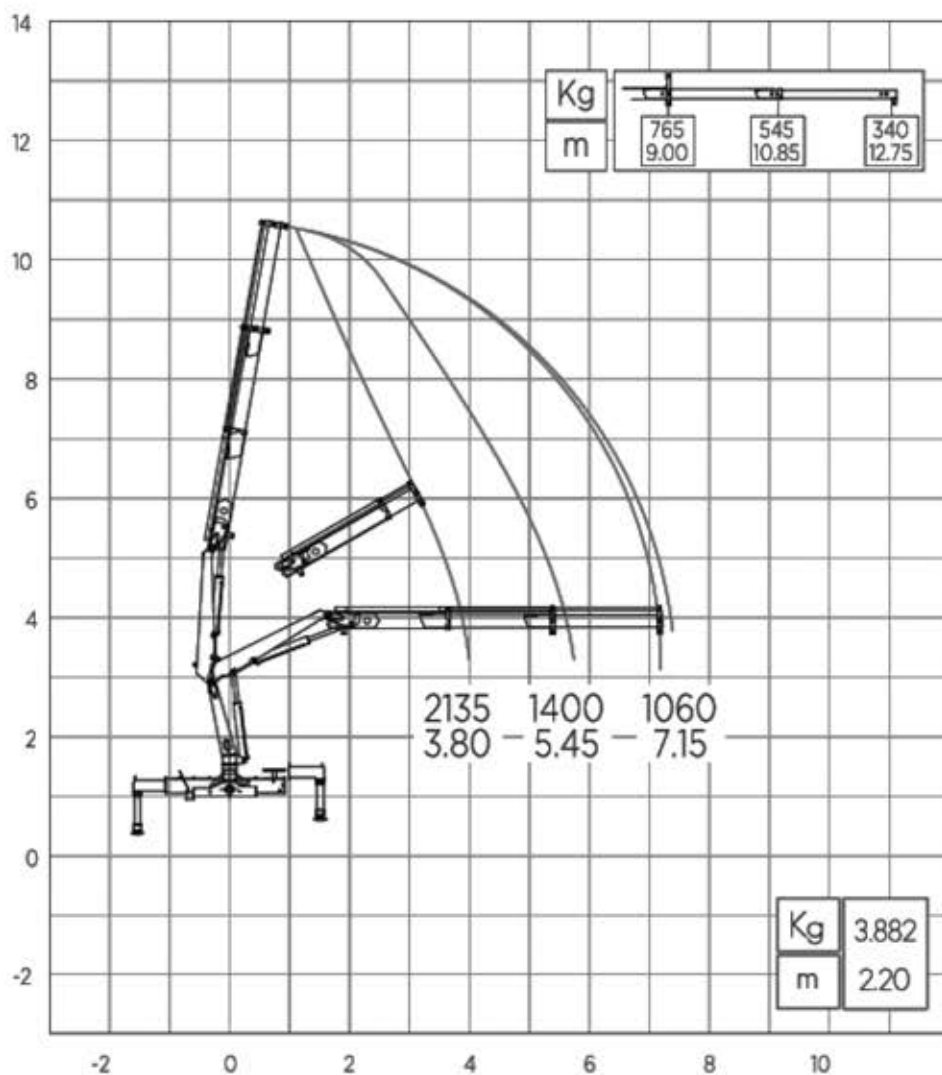

OIL & STEEL





PM 9023

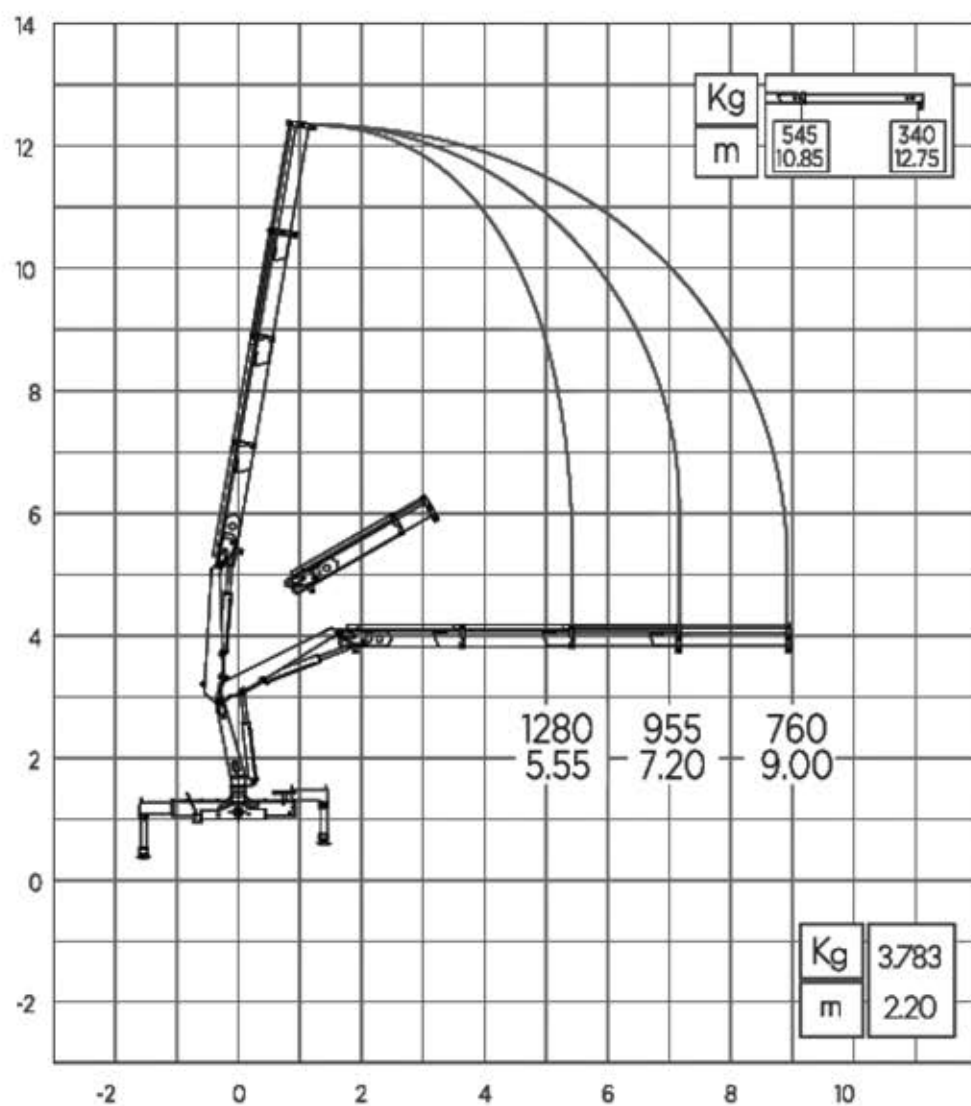

OIL & STEEL





PM 9024

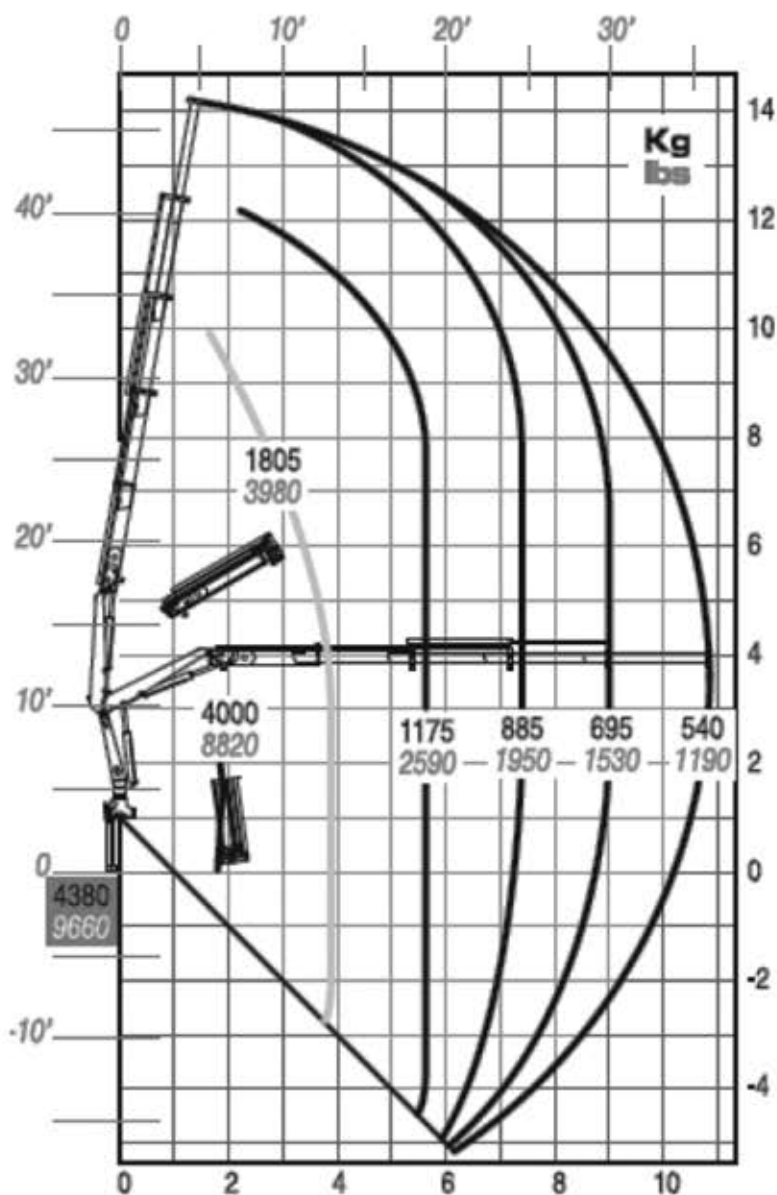

OIL & STEEL



PM LATIN AMÉRICA

- **PM Argentina Sistemas De Elevación S.A.**

Intendente Neyer 1133. Unid. 15
C.P 1643 Beccar
Prov. De Buenos Aires. Argentina
Tel: +54 11 4732 9008

- **PM Oil&Steel México SA de CV**

Acceso V, 115-B
Nave 21 - Manzana 1
Polígono Industrial Montaña 2000
Sección III - CP. 76150
Santiago de Querétaro,
Querétaro. México.
Tel: +52 442 210 2753

- **PM Oil&steel do Brasil Sistemas de Elevacoes Ltda**

Av. Pacaembu 840, Sala: 01;
CO. 01234-000 Pacaembu, Sao Paulo,
SP. Brasil
info@pm-latinamerica.com

- **PM Chile SpA**

Alcalde Guzmán N°0121
Galpón Pyme 3. Quilicura
Santiago. Chile
Tel: + 56 2 2763 0300
Filial. Antofagasta:
Pirita 12450, Galpón 24,
Centro Industrial Exportador
de Antofagasta CIE, Chile
Tel: +56 55 2426070

- **Grúas PM Perú SAC**

Mariano de los Santos 198
Ofi. 304
San Isidro, Lima 27
Lima. Perú.
Tel: +51 1 4228952

www.pm-latinamerica.com
info@pm-latinamerica.com

Síguenos en nuestras redes sociales.
Únete a la Familia PM!



Los datos técnicos pueden ser modificados sin previo aviso y pueden quedar sujetos a tolerancia. La elección del camión es responsabilidad del cliente. La viabilidad del conjunto debe ser avalada a través de un proyecto de instalación que verifique la estabilidad del conjunto y el reparto de carga sobre los ejes.

